



JH3S-X/JH3S-B

Stainless Steel Free Float Steam Trap

Features

A reliable and durable stainless steel steam trap for use on small-size process equipment. JH3S-B is also suitable for both superheated and high-pressure process equipment.

1. Self-modulating free float provides continuous, smooth, low-velocity condensate discharge as process loads vary.
2. Precision-ground float, constant water seal and three-point seating design ensure a steam-tight seal, even under no-load conditions.
3. **JH3S-X**: Thermostatic capsule (X-element) with "fail open" feature vents air automatically at close-to-steam temperature.
4. **JH3S-B**: Thermostatic bimetal air vent valve vents air automatically for rapid startup.
5. Built-in screen with large surface area ensures extended trouble-free operation.
6. Easy, inline access to internal parts simplifies cleaning and reduces maintenance costs.



Pressure Equipment Directive (PED)

Classification according to PED 2014/68/EU, fluid group 2

Size	Category	CE marking
DN 15 to DN 25	—*	Art. 4, Sec. 3 (sound engineering practice), CE marking not allowed

* Manufactured in accordance with sound engineering practice

Specifications

Model	JH3S-X			JH3S-B		
	Screwed	Socket Welded	Flanged	Screwed	Socket Welded	Flanged
Connection						
Size	1/2", 3/4", 1"	DN 15, 20, 25		1/2", 3/4", 1"	DN 15, 20, 25	
Orifice No.	2, 5, 10, 14, 22, 32			2, 5, 10, 14, 22, 32		
Maximum Operating Pressure (barg) PMO	2, 5, 10, 14, 22, 32			2, 5, 10, 14, 22, 32		
Maximum Differential Pressure (bar) ΔPMX	2, 5, 10, 14, 22, 32			2, 5, 10, 14, 22, 32		
Maximum Operating Temperature (°C) TMO	240			350		
Type of Air Vent	X-element (6 °C subcooling)			Bimetal (vents air up to approx. 100 °C)		

PRESSURE SHELL DESIGN CONDITIONS (NOT OPERATING CONDITIONS): Maximum Allowable Pressure (barg) PMA: 32 1 bar = 0.1 MPa
Maximum Allowable Temperature (°C) TMA: 350

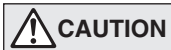

To avoid abnormal operation, accidents or serious injury, DO NOT use this product outside of the specification range. Local regulations may restrict the use of this product to below the conditions quoted.

No.	Description	Material	DIN ¹⁾	ASTM/AISI ¹⁾
①	Body	Cast Stainless Steel A351 Gr.CF8	1.4312	—
②	Cover	Cast Stainless Steel A351 Gr.CF8	1.4312	—
③ ^F	Float	Stainless Steel SUS316L	1.4404	AISI316L
④ ^R	Orifice	—	—	—
⑤ ^{MR}	Orifice Gasket	Stainless Steel SUS316L	1.4404	AISI316L
⑥	Orifice Plug	Cast Stainless Steel A351 Gr.CF8	1.4312	—
⑦ ^{MR}	Orifice Plug Gasket	Stainless Steel SUS316L	1.4404	AISI316L
⑧ ^{MR}	Cover Gasket	Graphite/Stainless Steel SUS316L	~1.4404	~AISI316L
⑨ ^R	Float Cover	Stainless Steel SUS304	1.4301	AISI304
⑩ ^R	Screen inside/outside ²⁾	Stainless Steel SUS430/304	1.4016/1.4301	AISI430/304
⑪ ^R	Spring Clip	Stainless Steel SUS304	1.4301	AISI304
⑫ ^R	X-element Guide	Stainless Steel SUS304	1.4301	AISI304
⑬ ^R	Air Vent Valve Seat	Stainless Steel SUS420F	1.4028	AISI420F
⑭ ^R	X-element	Stainless Steel	—	—
⑮ ^R	Snap Ring	Stainless Steel SUS304	1.4301	AISI304
⑯ ^R	Air Vent Case	Cast Stainless Steel A351 Gr.CF8	1.4312	—
⑰ ^R	Bimetal Plate	Bimetal	—	—
⑱ ^R	Air Vent Screen	Stainless Steel SUS304	1.4301	AISI304
⑲ ^R	Air Vent Valve Seat	—	—	—
⑳ ^R	Air Vent Valve Plug	—	—	—
㉑ ^R	Snap Ring	Stainless Steel SUS304	1.4301	AISI304
㉒	Connector	Stainless Steel SUS416	1.4005	AISI416
㉓	Cover Bolt	Stainless Steel SUS304	1.4301	AISI304
㉔	Nameplate	Stainless Steel SUS304	1.4301	AISI304
㉕	Socket ³⁾ /Flange ³⁾	Cast Stainless Steel A351 Gr.CF8	1.4312	—
㉖	Drain Plug Gasket ⁴⁾	Stainless Steel SUS316L	1.4404	AISI316L
㉗	Drain Plug ⁴⁾	Stainless Steel SUS303	1.4305	AISI303

¹⁾ Equivalent materials ²⁾ JH3S-B: inside only ³⁾ Shown on reverse ⁴⁾ Option
Replacement kits available: (M) maintenance parts, (R) repair parts, (F) float

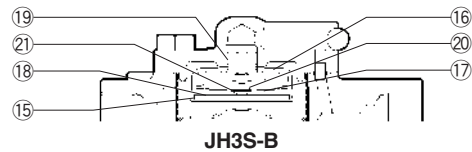

JH3S-B

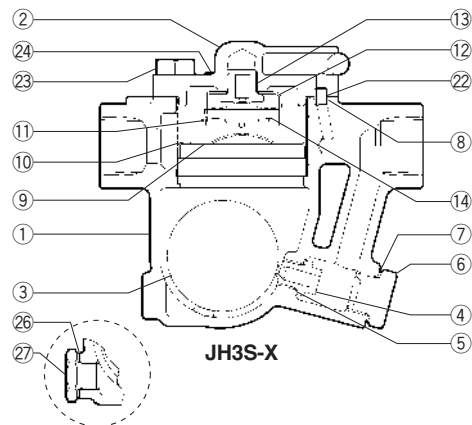

JH3S-X

Dimensions

• JH3S-X/JH3S-B Screwed

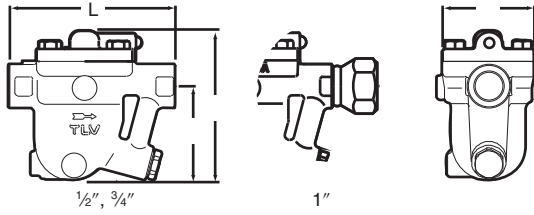

JH3S-X/JH3S-B Screwed* (mm)

Size	L	H	H ₁	W	Weight (kg)
1/2"	145	129	82	80	2.7
3/4"					2.8
1"	203				

* BSP DIN 2999, other standards available

• JH3S-X/JH3S-B Socket Welded

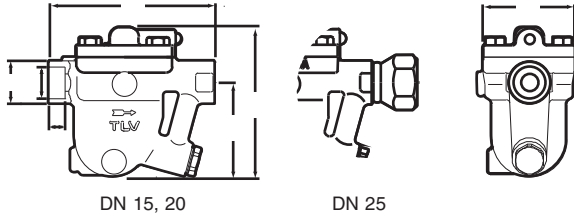

JH3S-X/JH3S-B Socket Welded* (mm)

DN	L	H	H ₁	W	φD	φC	h	Weight (kg)
15	145	129	82	80	36	21.8	12	2.7
20							14	
25	203				44	33.9		2.8

* ASME B16.11-2005, other standards available

• JH3S-X/JH3S-B Flanged

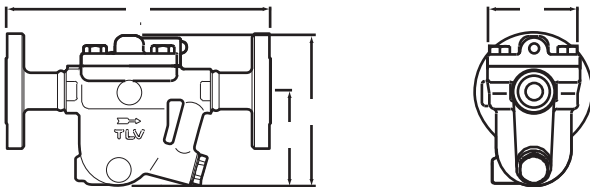

JH3S-X/JH3S-B Flanged (mm)

DN	L			H	H ₁	W	Weight* (kg)
	ASME Class						
	150RF	300RF	600RF				
15	210	210	220	129	82	80	4.3
20	230	230	230				5.1
25	250	250	250				5.8

Other standards available, but length and weight may vary

* Weight is for Class 600 RF

Discharge Capacity

• JH3S-X

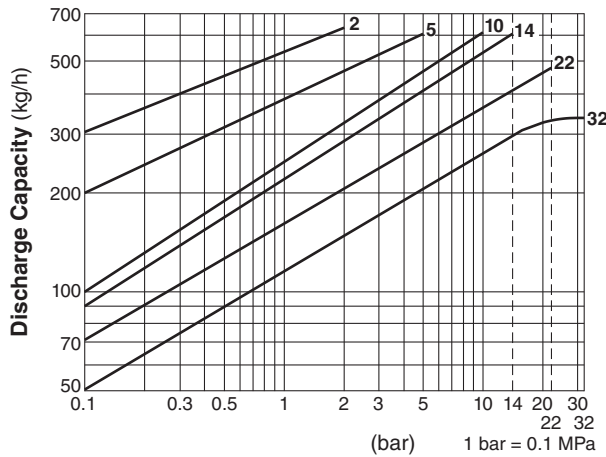

• JH3S-B

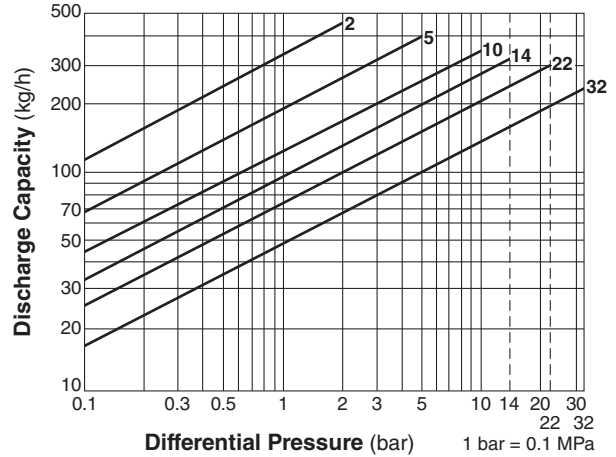

1. Line numbers within the graph are orifice numbers.
2. Differential pressure is the difference between the inlet and outlet pressure of the trap.
3. Capacities are based on continuous discharge of condensate 6°C below saturated steam temperature.
4. Recommended safety factor: at least 1.5.

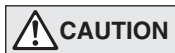

CAUTION

DO NOT use this product under conditions that exceed maximum differential pressure, as condensate backup will occur!